

# Fabric Button Stencil

**Made from:** stretch or non stretch fabric, stretch or non-stretch conductive fabric, fusible interfacing, foam, (metal poppers)  
**Range:** 2 K Ohm - 200 Ohm

[www.KOBAKANT.at](http://www.KOBAKANT.at)

SIDE A

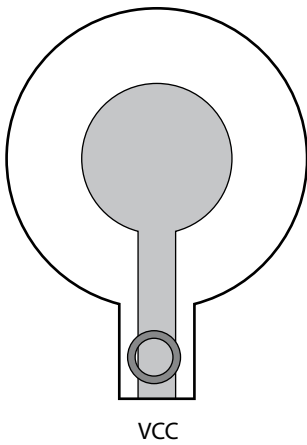



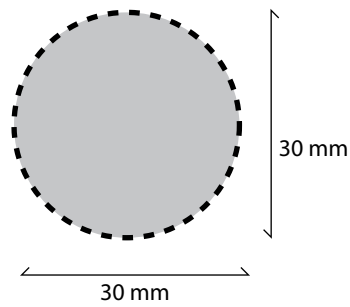



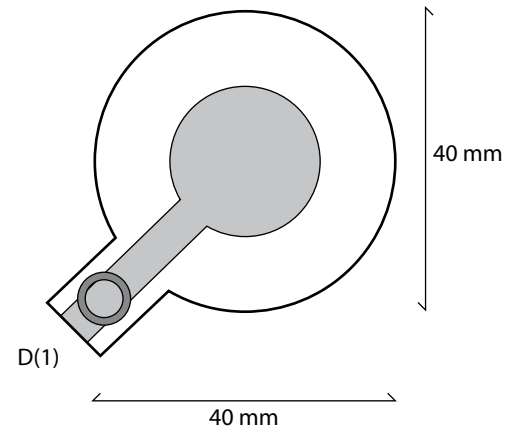

IN BETWEEN





SIDE B



	Neoprene
	Conductive fabric
	Perforated foam
	Isolation
	Velostat/Eeonyx

	Conductive thread
	Isolated conductive thread
	Fold
	Outline

	7mm/11L metal popper
	Knot
VCC	Common GND or +5V
A/D(1-4)	Analog/Digital in/outputs