

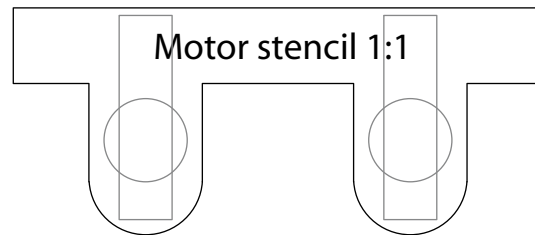

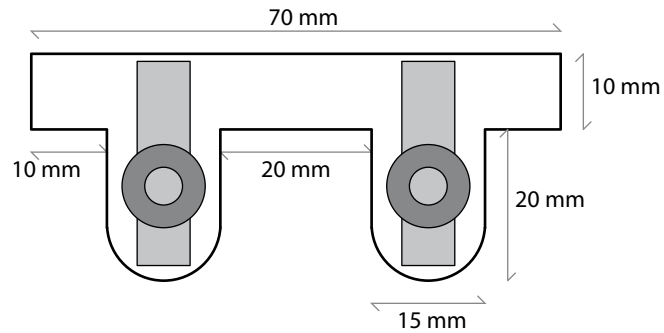









Neoprene Motor Pouch Stencil

Made from: 1.5 mm thick HS quality neoprene with polyester jersey fused to either side, stretch conductive fabric, fusible interfacing, regular thread, (metal poppers)

Fits: standard force-feedback motors from a game controllers

www.KOBAKANT.at



	Neoprene		Conductive thread		Metal popper
	Conductive fabric		Isolated conductive thread		Knot
	Perforated foam		Fold	VCC	Common GND or +5V
	Isolation		Outline	A/D(1-4)	Analog/Digital in/outputs
	Velostat/Eeonyx				