

# Single AA Battery Pouch (short legs)





## Stencil



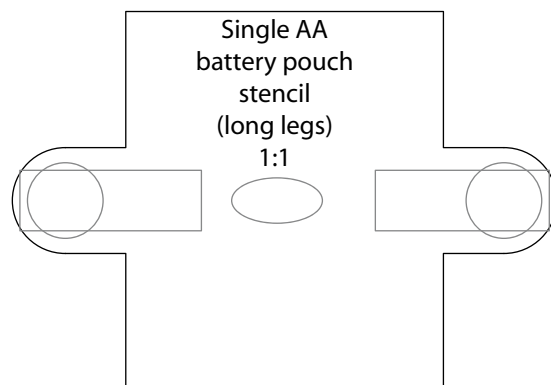
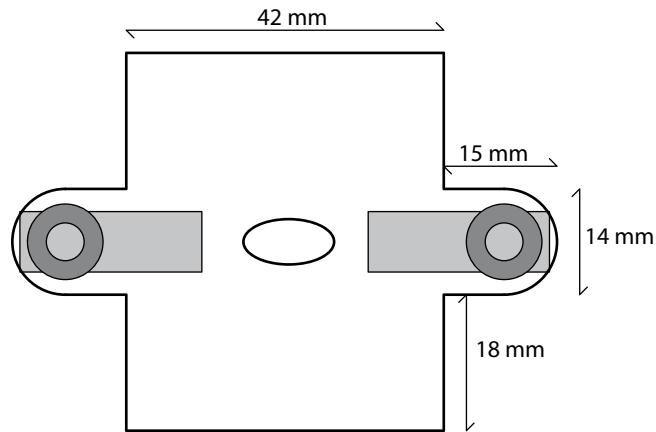

**Made from:** 1.5 mm thick HS quality neoprene with polyester jersey fused to either side, stretch conductive fabric, fusible interfacing, regular thread



**Fits:** one single AA Battery

[www.KOBAKANT.at](http://www.KOBAKANT.at)



	Neoprene
	Conductive fabric
	Perforated foam
	Isolation
	Velostat/Eeonyx

	Conductive thread
	Isolated conductive thread
	Fold
	Outline

	Metal popper
	Knot
VCC	Common GND or +5V
A/D(1-4)	Analog/Digital in/outputs